

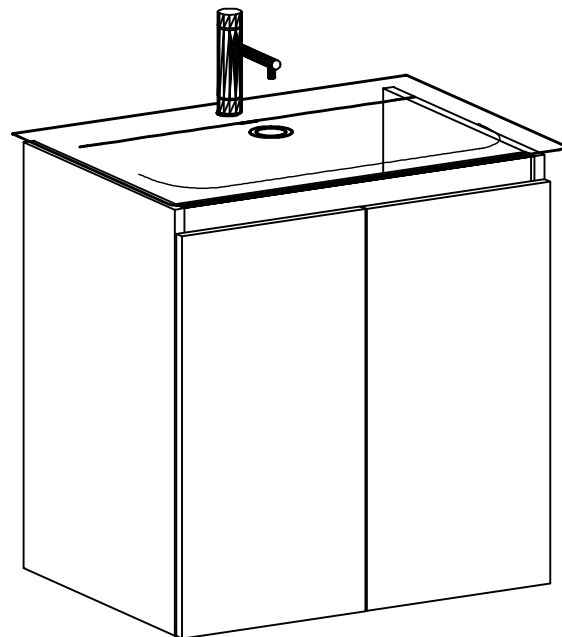

FROIDEVAUX

**Massskizze / Dessin technique
CONNECT AIR 64 cm Standard**

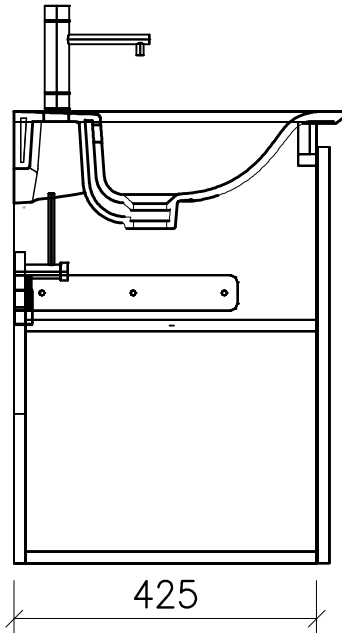
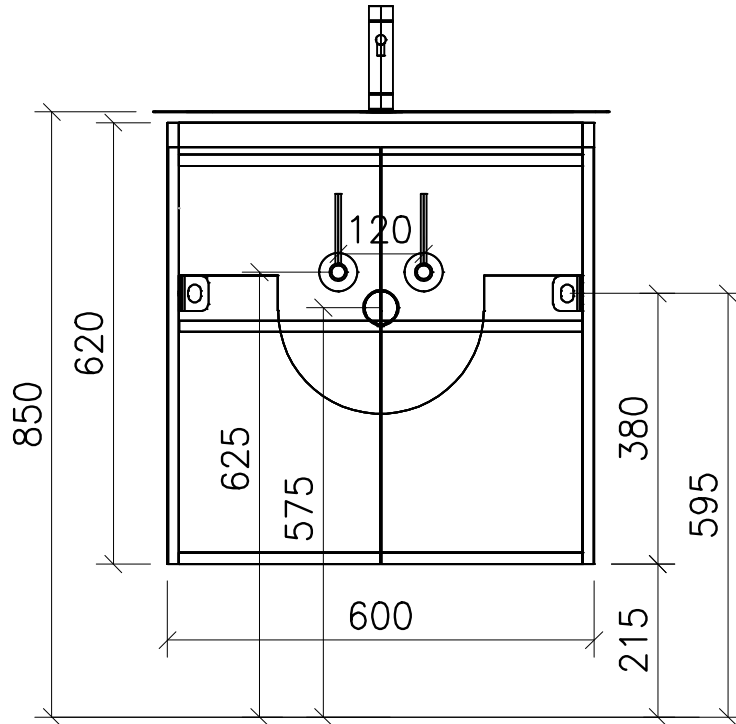

	Datum	Name
Gezeichnet	18.12.17	V. Wolfer
Geprüft		
Geändert		
Massstab	1:10	
Artikelnr.		
Zeichnung	Connect Air 64 cm.dwg	