

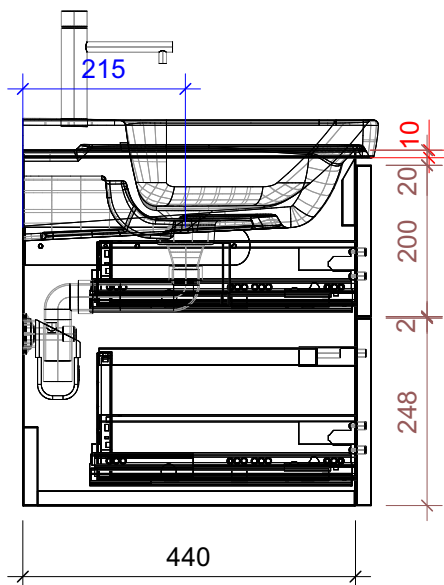

FROIDEVAUX

Subway 3.0 65 cm DOPPIO
 mit Griffen oder Tippmechanismus
 avec poignées ou push open

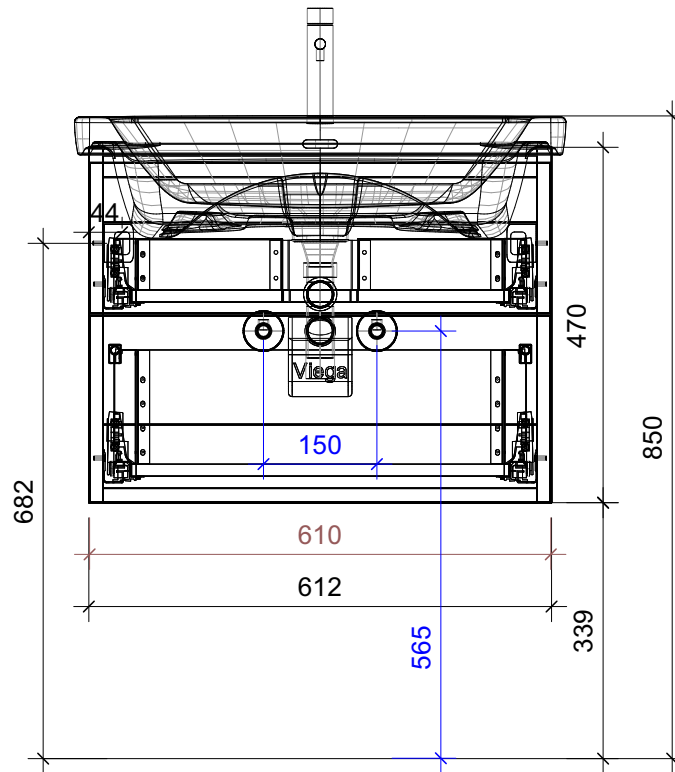

	Datum	Name
Gezeichnet	20.06.2024	CW
Geändert		
Masstab	1:10	
Artikelnr.	066.161-164	